



OWNER'S MANUAL

MC1000

MC2300

MC3500

PORTABLE INVERTER GENERATOR

SAVE THESE INSTRUCTIONS
Important Safety Instructions
are included in this manual.

*We are always working to improve our products. Therefore, the enclosed product may differ slightly from the image on the cover.

INTRODUCTION

Introduction

Congratulations on your purchase of Our inverter generator. designs and builds generators to strict specifications. With proper use and maintenance, this generator will bring years of satisfying service.

Portable Power Generator

This unit is a gasoline engine driven, alternating current (AC) generator. It is designed to supply electrical power for lighting, appliances, tools and similar equipment.

Accessories

Our manufactures and sells accessories designed to help you get the most from your purchase. To find out more about our covers, power cables and storm kits, please call us:

This Booklet

Every effort has been made to ensure the accuracy and completeness of the information in this manual. We reserve the right to change, alter and/or improve the product and this document at any time without prior notice.

Record the model and serial numbers as well as date and place of purchase for future reference. Have this information available when ordering parts and when making technical or warranty inquiries.

Model Number
Serial Number
Date of Purchase
Purchase Location
For Oil Type see 'Add Engine Oil' section. For Fuel Type see 'Add Fuel' section.

This manual uses the following symbols to help differentiate between different kinds of information. The safety symbol is used with a key word to alert you to potential hazards in operating and owning power equipment.

Follow all safety messages to avoid or reduce the risk of serious injury or death.

DANGER

DANGER indicates an imminently hazardous situation which, if not avoided, **will** result in death or serious injury.

CAUTION

CAUTION indicates a potentially hazardous situation which, if not avoided, **may** result in minor or moderate injury.

WARNING

WARNING indicates a potentially hazardous situation which, if not avoided, **could** result in death or serious injury.

CAUTION

CAUTION used without the safety alert symbol indicates a potentially hazardous situation which, if not avoided, **may** result in property damage.

SAFETY RULES

WARNING

Read this manual thoroughly before operating your generator. Failure to follow instructions could result in serious injury or death.

WARNING

The engine exhaust from this product contains chemicals known to the state of California to cause cancer, birth defects, or other reproductive harm.

DANGER

Generator exhaust contains carbon monoxide, a colorless, odorless, poison gas. Breathing carbon monoxide will cause nausea, dizziness, fainting or death. If you start to feel dizzy or weak, get to fresh air immediately.

Operate generator outdoors only in a well ventilated area.

DO NOT operate the generator inside any building, including garages, basements, crawlspaces and sheds, enclosure or compartment, including the generator compartment of a recreational vehicle. DO NOT allow exhaust fumes to enter a confined area through windows, doors, vents or other openings.

DANGER CARBON MONOXIDE: using a generator indoors **CAN KILL YOU IN MINUTES.**

DANGER

Rotating parts can entangle hands, feet, hair, clothing and/or accessories.
Traumatic amputation or severe laceration can result.

Keep hands and feet away from rotating parts.
Tie up long hair and remove jewelry.
Operate equipment with guards in place.
DO NOT wear loose-fitting clothing, dangling drawstrings or items that could become caught.

DANGER

Generator produces powerful voltage.

DO NOT touch bare wires or receptacles.
DO NOT use electrical cords that are worn, damaged or frayed.
DO NOT operate generator in wet weather.
DO NOT allow children or unqualified persons to operate or service the generator
Use a ground fault circuit interrupter (GFCI) in damp areas and areas containing conductive material such as metal decking.
Use approved transfer equipment to isolate generator from your electric utility and Notify your utility company before connecting your generator to your power system.

WARNING

Sparks can result in fire or electrical shock.

When servicing the generator:

Disconnect the spark plug wire and place it where it cannot contact the plug.
DO NOT check for spark with the plug removed.
Use only approved spark plug testers.

WARNING

Running engines produce heat. Severe burns can occur on contact.
Combustible material can catch fire on contact.

DO NOT touch hot surfaces.
Avoid contact with hot exhaust gases.
Allow equipment to cool before touching.
Maintain at least three feet of clearance on all sides to ensure adequate cooling.
Maintain at least five feet of clearance from combustible materials.

WARNING

Medical and Life Support Uses.

In case of emergency, call 000 immediately.
NEVER use this product to power life support devices or life support appliances.
NEVER use this product to power medical devices or medical appliances.
Inform your electricity provider immediately if you or anyone in your household depends on electrical equipment to live.
Inform your electrical provider immediately if a loss of power would cause you or anyone in your household to experience a medical emergency.

DANGER

Fuel and fuel vapors are highly flammable and extremely explosive.
Fire or explosion can cause severe burns or death.
Unintentional startup can result in entanglement, traumatic amputation or laceration.

When adding or removing fuel:

Turn the generator off and let it cool for at least two minutes before removing the fuel cap. Loosen the cap slowly to relieve pressure in the tank.
Only fill or drain fuel outdoors in a well-ventilated area. DO NOT pump gas directly into the generator at the gas station. Use an approved container to transfer the fuel to the generator.
DO NOT overfill the fuel tank.
Always keep fuel away from sparks, open flames, pilot lights, heat and other sources of ignition.
DO NOT light or smoke cigarettes.

When starting the generator:

DO NOT attempt to start a damaged generator.
Make certain that the gas cap, air filter, spark plug, fuel lines and exhaust system are properly in place.
Allow spilled fuel to evaporate fully before attempting to start the engine.
Make certain that the generator is resting firmly on level ground.

When operating the generator:

DO NOT move or tip the generator during operation.
DO NOT tip the generator or allow fuel or oil to spill.

When transporting or servicing the generator:

Make certain that the fuel shutoff valve is in the off position and the fuel tank is empty.
Disconnect the spark plug wire.
When storing the generator:
Store away from sparks, open flames, pilot lights, heat and other sources of ignition.

WARNING

Operation of this equipment may create sparks that can start fires around dry vegetation.

A spark arrestor may be required. The operator should contact local fire agencies for laws or regulations relating to fire prevention requirements.

WARNING

Rapid retraction of the starter cord will pull hand and arm towards the engine faster than you can let go.
Unintentional startup can result in entanglement, traumatic amputation or laceration.
Broken bones, fractures, bruises or sprains could result.

When starting engine, pull the starter cord slowly until resistance is felt and then pull rapidly to avoid kickback.
DO NOT start or stop the engine with electrical devices plugged in.

CAUTION

Exceeding the generator's running capacity can damage the generator and/or electrical devices connected to it.

DO NOT overload the generator.
Start the generator and allow the engine to stabilize before connecting electrical loads.
Connect electrical equipment in the off position, and then turn them on for operation.
Turn electrical equipment off and disconnect before stopping the generator.
DO NOT tamper with the governed speed.
DO NOT modify the generator in any way.

CAUTION

Improper treatment or use of the generator can damage it, shorten its life and void your warranty.

Use the generator only for intended uses.
Operate only on level surfaces.
DO NOT expose generator to excessive moisture, dust, or dirt.
DO NOT allow any material to block the cooling slots.
If connected devices overheat, turn them off and disconnect them from the generator.
DO NOT use the generator if:
– Electrical output is lost
– Equipment sparks, smokes or emits flames
– Equipment vibrates excessively

CONTROLS AND FEATURES

Read this owner's manual before operating your generator. Familiarize yourself with the location and function of the controls and features. Save this manual for future reference.

Inverter

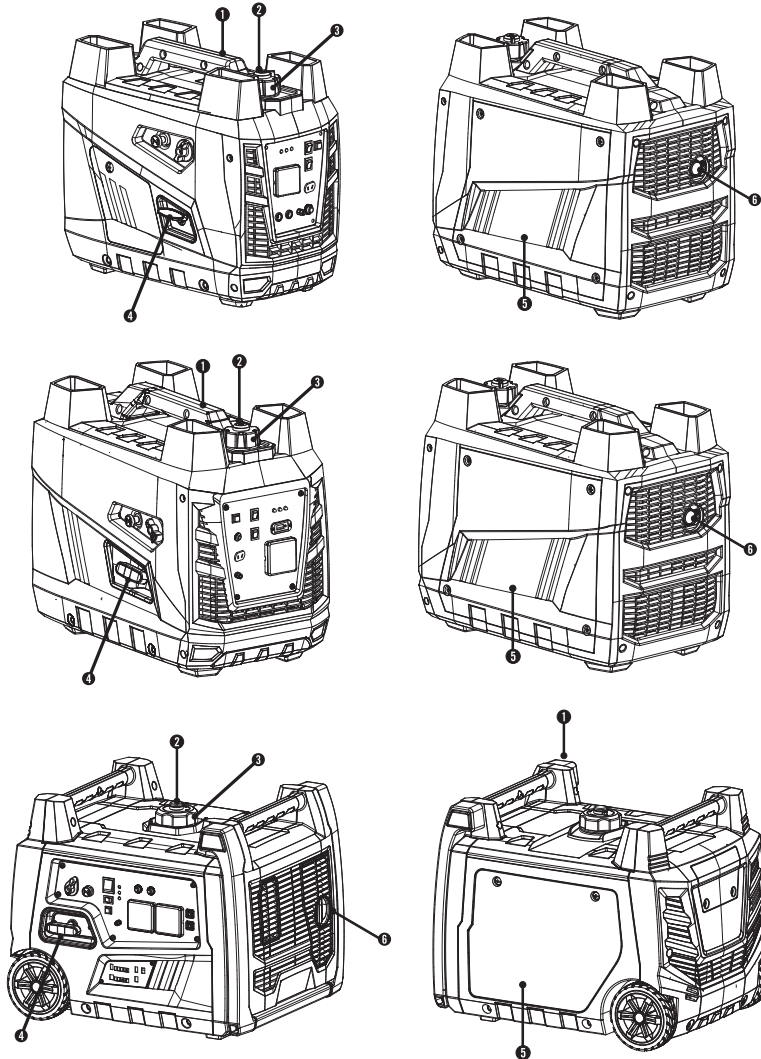

- (1) **Carrying Handle**
- (2) **Fuel Lever Vent** – Turn this valve to the “On” position to supply air to the tank.
- (3) **Fuel Cap** – Remove to add fuel.
- (4) **Recoil Starter** – Used to start the engine.
- (5) **Maintenance Cover** – Oil filler, Air filter, and Carburetor access.
- (6) **Muffler**

Parts Included

Your Gasoline Powered Generator ships with the following parts:

- Oil Funnel 1
- Spark Plug Socket 1

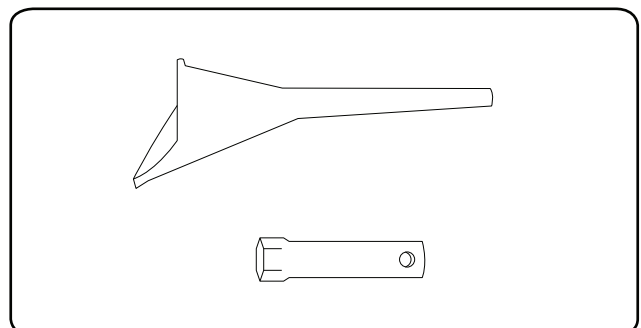

ASSEMBLY

Your generator requires some assembly. This unit ships from our factory without oil. It must be properly serviced with fuel and oil before operation.

Remove the Generator from the Shipping Carton

1. Set the shipping carton on a solid, flat surface.
2. Remove everything from the carton except the generator.
3. Using the handle of the unit, carefully remove the generator from the box.

Add Engine Oil

! CAUTION

DO NOT attempt to crank or start the engine before it has been properly filled with the recommended type and amount of oil. Damage to the generator as a result of failure to follow these instructions will void your warranty.

1. Place the generator on a flat, level surface.
2. Loosen the cover screws and remove the maintenance cover.

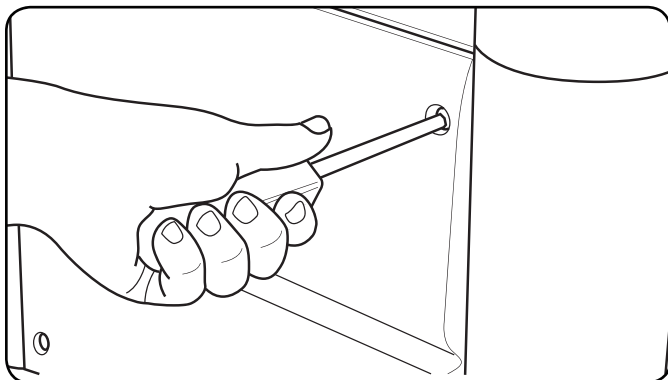

3. Remove oil fill cap/dipstick to add oil.

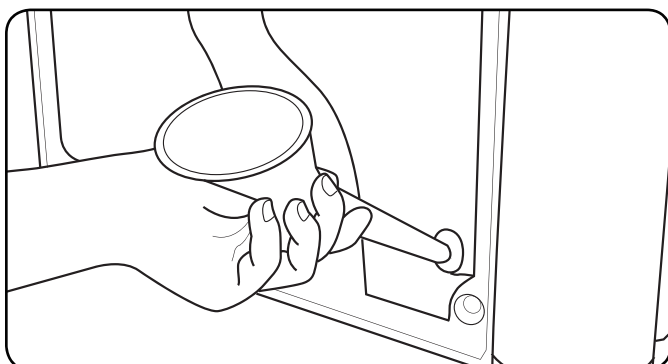

4. 1kw generator add 0.32L/2kw generator add 0.45L/3kw generator add 0.6L of oil and replace oil fill cap/dipstick.

Add Engine Oil Cont'd.

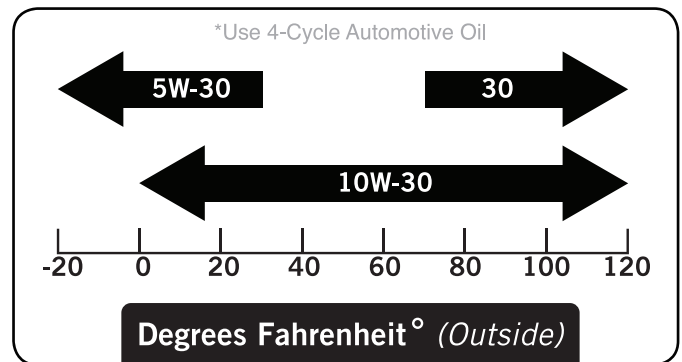

5. Check engine oil level daily and add as needed.

CAUTION

The engine is equipped with a low-oil-shutoff and will stop when the oil level in the crankcase falls below the threshold level.

NOTE

The recommended oil type is 10W-30 4-cycle automotive oil.

NOTE

Check oil often during the break-in period. Refer to the Maintenance section for recommended service intervals.

Add Fuel

1. Use clean, fresh, regular unleaded fuel with a minimum octane rating of 85 and an ethanol content of less than 10% by volume.
2. DO NOT mix oil with fuel.
3. Clean the area around the fuel cap.
4. Remove the fuel cap.
5. Slowly add the fuel in the tank. DO NOT fill fully. Leave about 0.25 inch (0.64 cm) for the expansion of fuel.
6. Screw on the fuel cap and wipe away any spilled fuel.

CAUTION

Use regular unleaded gasoline with a minimum octane rating of 85.

Do not mix oil and gasoline.
Fill tank to approximately ¼" below the top of the tank to allow for fuel expansion.
DO NOT pump gas directly into the generator at the gas station. Use an approved container to transfer the fuel to the generator.
DO NOT fill fuel tank indoors.
DO NOT fill fuel tank when the engine is running or hot.
DO NOT overfill the fuel tank.
DO NOT light cigarettes or smoke when filling the fuel tank.

WARNING

Pouring fuel too fast through the fuel screen may result in blow back of fuel at the operator while filling.

Grounding

Your generator must be properly connected to an appropriate ground to help prevent electric shock.

WARNING

Failure to properly ground the generator can result in electric shock.

A ground terminal connected to the frame of the generator has been provided on the power panel. For remote grounding, connect a length of heavy gauge (12 AWG minimum) copper wire between the generator ground terminal and a copper rod driven into the ground. We strongly recommend that you consult with a qualified electrician to ensure compliance with local electrical codes.

OPERATION

Generator Location

DANGER CARBON MONOXIDE, using a generator indoors **CAN KILL YOU IN MINUTES**. Generator exhaust contains carbon monoxide (CO). This is a poison gas you cannot see or smell. If you can smell of the generator gas you are breathing CO. But even if you cannot smell the exhaust, you could be breathing CO.

NEVER operate the generator inside any building, including garages, basements, crawlspaces and sheds, enclosure or compartment, including the generator compartment of a recreational vehicle. Deadly levels of carbon monoxide can build up in these areas. Using a fan or opening windows and doors does **NOT** supply enough fresh air.

Please consult your local authority. In some areas, generators must be registered with the local utility. Generators used at construction sites may be subject to additional rules and regulations.

This generator must have at least five feet of clearance from combustible material. Leave at least three feet of clearance on all sides of the generator to allow for adequate cooling, maintenance and servicing.

Place the generator in a well-ventilated area far away from windows door, and vents. **DO NOT** place the generator near vents or intakes where exhaust fumes could be drawn into occupied or confined spaces. Carefully consider wind and air currents when positioning generator.

Even when using a generator correctly, carbon monoxide may leak into the home. use a battery-powered or battery- backup CO alarm in the home. If you start to feel sick, dizzy, or weak after the generator has been running, move to fresh air **RIGHT AWAY**. See a doctor, you could have carbon monoxide poisoning.

WARNING

Do not operate or store the generator in rain, snow, or wet weather.

Using a generator or electrical appliance in wet conditions, such as rain or snow, or near a pool or sprinkler system, or when your hands are wet, could result in electrocution.

Starting the Engine

1. Make certain the generator is on a flat, level surface.
2. Disconnect all electrical loads from the generator.
Never start or stop the generator with electrical devices plugged in or turned on.
3. Turn the fuel cap vent lever to the “On” position.

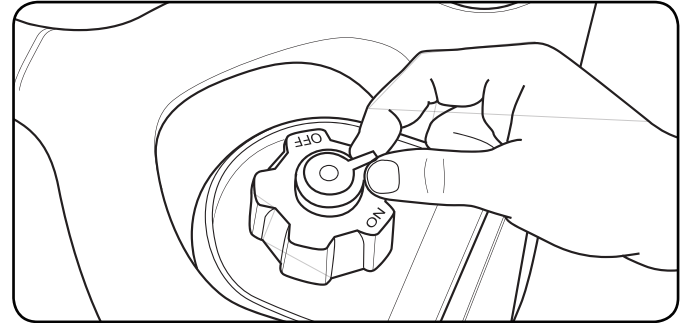

4. Turn the fuel valve to the “On” position.

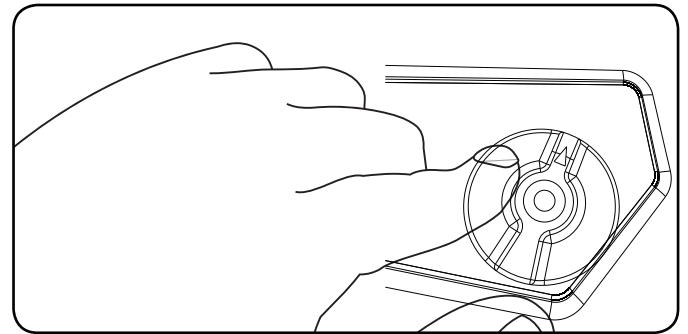

5. Slide choke lever right to the “Choke” position.

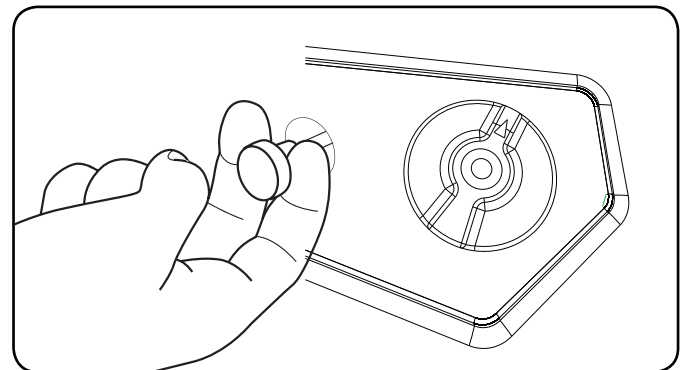

6. Turn the engine switch to the “On” position.

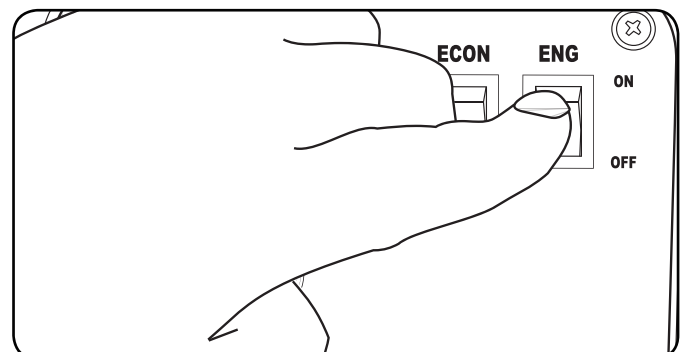

Starting the Engine Cont'd.

7. Pull the starter cord slowly until resistance is felt and then pull rapidly.

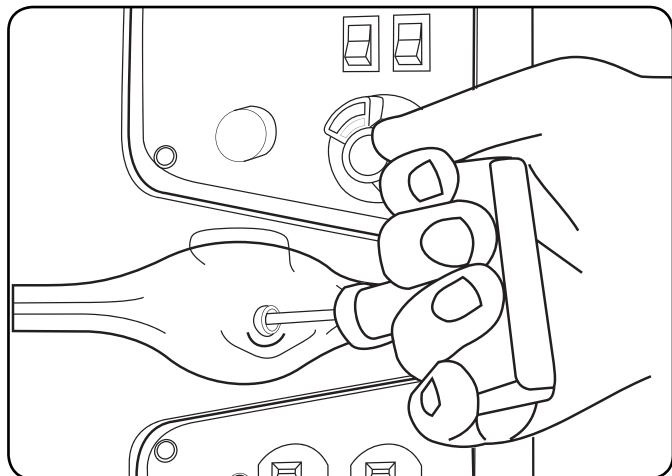

8. As engine warms up, slide the choke lever left to the "Run" position.

NOTE

If the engine starts but does not stay running make certain that the generator is on a flat, level surface. The engine is equipped with a low oil sensor that will prevent the engine from running when the oil level falls below a critical threshold.

Economy Control Switch

The Economy Control switch can be activated in order to minimize fuel consumption and noise while operating the unit during times of **reduced electrical output**, allowing the engine speed to idle during periods of non-use. The engine speed returns to normal when an electrical load is connected. When the economy switch is off, the engine runs at normal speed continuously.

WARNING

For periods of high electrical load or momentary fluctuations, the Economy Control Switch should be turned OFF.

Connecting Electrical Loads

1. Let the engine stabilize and warm up for a few minutes after starting
2. Plug in and turn on the desired 220 Volt AC single phase, 50 Hz electrical loads.
 - DO NOT connect 3-phase loads to the generator.
 - DO NOT overload the generator.

NOTE

Connecting a generator to your electric utility company's power lines or to another power source may be against the law. In addition this action, if done incorrectly, could damage your generator and appliances and could cause serious injury or even death to you or a utility worker who may be working on nearby power lines. If you plan to run a portable electric generator during an outage, please notify your electric utility company immediately and remember to plug your appliances directly into the generator. Do not plug the generator into any electric outlet in your home. Doing so could create a connection to the utility company power lines. You are responsible for ensuring that your generator's electricity does not feed back into the electric utility power lines.

If the generator will be connected to a building electrical system, consult your local utility company or a qualified electrician. Connections must isolate generator power from utility power and must comply with all applicable laws and codes.

OPERATION

Battery Charging

The DC receptacle should ONLY be used for charging 12V automotive type batteries. The DC charging output is not regulated. When using the DC output, turn the Eco-Throttle switch to the "OFF" position.

⚠ CAUTION

Do not start the vehicle while the battery charging cable is connected and the generator is running. The vehicle or the generator may be damaged.

💬 NOTE

Be sure all electric devices including the lines and plug connections are in good condition before connection to the generator.

DC 12V (3500 model)

1. Before connecting the battery charging cable to a battery that is installed in a vehicle, disconnect the vehicle battery ground cable from the negative (-) battery terminal.
2. Plug the battery charging cable into the DC receptacle of the generator.
3. Connect the red (+) battery charger lead to the red (+) battery terminal.
4. Connect the black (-) battery charger lead to the black (-) battery terminal.
5. Start the generator.

Stopping the Engine

1. Turn off and unplug all electrical loads. Never start or stop the generator with electrical devices plugged in or turned on.
2. Let the generator run at no-load for several minutes to stabilize internal temperatures of the engine and generator.
3. Turn the engine switch/fuel valve to the "Off" position.
4. Allow the generator to cool down completely to room temperature
5. Turn the fuel cap lever vent to the "Off" position after the generator has cooled down completely.

Do Not Overload Generator

Capacity

Follow these simple steps to calculate the running and starting watts necessary for your purposes.

1. Select the electrical devices you plan on running at the same time.
2. Total the running watts of these items. This is the amount of power you need to keep your items running.
3. Identify the highest starting wattage of all devices identified in step 1. Add this number to the number calculated in step 2. Surge wattage is the extra burst of power needed to start some electric driven equipment. Following the steps listed under "Power Management" will guarantee that only one device will be starting at a time.

Power Management

Use the following formula to convert voltage and amperage to watts:

$$\text{Volts} \times \text{Amps} = \text{Watts}$$

To prolong the life of your generator and attached devices, follow these steps to add electrical load:

1. Start the generator with no electrical load attached
2. Allow the engine to run for several minutes to stabilize.
3. Plug in and turn on the first item. It is best to attach the item with the largest load first.
4. Allow the engine to stabilize.
5. Plug in and turn on the next item.
6. Allow the engine to stabilize.
7. Repeat steps 5-6 for each additional item.

💬 NOTE

Never exceed the specified capacity when adding loads to the generator.

MAINTENANCE AND STORAGE

The owner/operator is responsible for all periodic maintenance.

⚠ WARNING

Never operate a damaged or defective generator.

⚠ WARNING

Tampering with the factory set governor will void your warranty.

⚠ WARNING

Improper maintenance will void your warranty.

💬 NOTE

Maintenance, replacement, or repair of emission control devices and systems may be performed by any non-road engine repair establishment or individual.

Complete all scheduled maintenance in a timely manner. Correct any issue before operating the generator.

Engine Maintenance

To prevent accidental starting, remove and ground spark plug wire before performing any service.

Oil

Change oil when the engine is warm. Refer to the oil specification to select the proper grade of oil for your operating environment.

1. Loosen the cover screws and remove the maintenance cover.
2. Remove the oil filler cap.
3. Tilt the generator on its side and allow the oil to drain completely.
4. 1kw generator add 0.32L/2kw generator add 0.45L/3kw generator add 0.6L of oil and replace oil fill cap/dipstick.
5. Reinstall the maintenance cover and tighten the cover screws.
6. Dispose of used oil at an approved waste management facility.

Oil Cont'd.

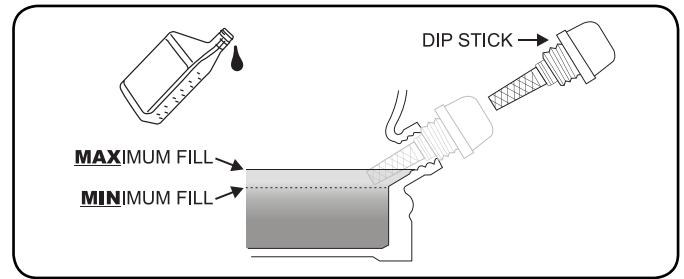

Spark Plugs

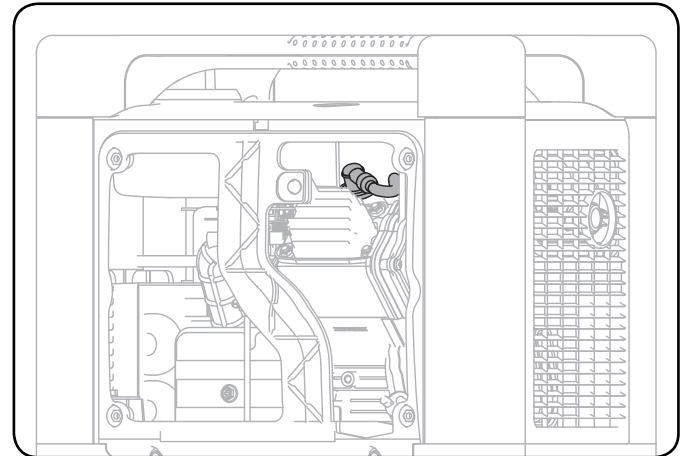

1. Remove the maintenance cover.
2. Remove the spark plug cable from the spark plug.
3. Use the spark plug tool that shipped with your generator to remove the plug. Remove the spark plug access cap and insert the spark plug tool through this hole.
4. Remove the spark plug.
5. Inspect the electrode on the plug. It must be clean and not worn to produce the spark required for ignition.
6. Make certain the spark plug gap is 0.6 - 0.7 mm (0.024 - 0.028 in.).

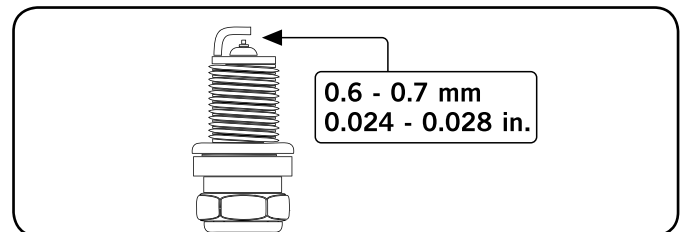

7. Carefully thread the plug into the engine.
8. Use the spark plug tool to firmly install the plug.
9. Attach the spark plug cap to the plug.
10. Reinstall the spark plug access cap, and maintenance cover.

Air Filter

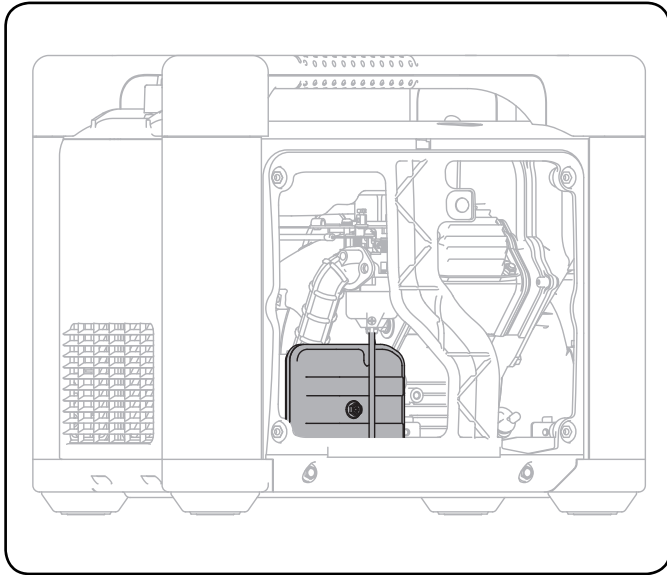

1. Remove the maintenance cover.
2. Locate the air filter plastic cover. Remove the screw using a Phillips head screwdriver.
3. Remove the foam element.
4. Wash in liquid detergent and water. Squeeze thoroughly dry in a clean cloth.
5. Saturate in clean engine oil.
6. Squeeze in a clean, absorbent cloth to remove all excess oil.
7. Place the filter in the assembly.
8. Reattach the air filter cover.
9. Reinstall the maintenance cover and tighten the cover screw securely.

Cleaning

! CAUTION

DO NOT spray engine with water.

Water can contaminate the fuel system.

Use a damp cloth to clean exterior surfaces of the engine.

Use a soft bristle brush to remove dirt and oil.

Use an air compressor (25 PSI) to clear dirt and debris from the engine.

MAINTENANCE AND STORAGE

Adjustments

The air-fuel mixture is not adjustable. Tampering with the governor can damage your generator and your electrical devices and will void your warranty.

Maintenance Schedule

Follow the service intervals indicated in the following maintenance schedule.

Service your generator more frequently when operating in adverse conditions.

Every 8 hours or daily	
	Check oil level
	Clean around air intake and muffler
First 5 Hours	
	Change oil
Every 50 hours or every season	
	Clean air filter
	Change oil if operating under heavy load or in hot environments
Every 100 hours or every season	
	Change oil
	Clean/Adjust spark plug
	Check/Adjust valve clearance *
	Clean fuel tank and filter *
Every 3 years	
	Replace fuel line

*To be performed by knowledgeable, experienced owners or Power Equipment certified dealers.

Generator Maintenance

Make certain that the generator is kept clean and stored properly. Only operate the unit on a flat, level surface in a clean, dry operating environment. DO NOT expose the unit to extreme conditions, excessive dust, dirt, moisture or corrosive vapors.

⚠ CAUTION

DO NOT use a garden hose to clean the generator.

Water can enter the generator through the cooling slots and damage the generator windings.

Use a damp cloth to clean exterior surfaces of the generator.
Use a soft bristle brush to remove dirt and oil.
Use an air compressor (25 PSI) to clear dirt and debris from the generator.

Generator Maintenance Cont'd.

Inspect all air vents and cooling slots to ensure that they are clean and unobstructed.

Storage

The generator should be started at least once every 14 days and allowed to run for at least 20 minutes. For longer term storage, please follow these guidelines.

Generator Storage

1. Allow the engine to cool completely before storage.
2. Clean the generator according to the instructions in the Maintenance section.
3. Remove the maintenance cover. Drain all fuel completely from the fuel line and carburetor to prevent varnish build up.
4. Remove the spark plug cap, then pull the recoil grip 3 times to drain the gasoline from the carburetor jets.
5. Change the engine oil.
6. Remove the spark plug and pour about a tablespoon of oil into the cylinder. Crank the engine slowly to distribute the oil and lubricate the cylinder.
7. Reattach the spark plug.